









Guide to pH Analysis.



Contents

Table of Contents

	Why pH Matters	pg 4
	What You Need	pg 6
	How to Measure	pg 14
	Slope and offset	pg 18
	Checklist	pg 20
	Best Practices	pg 21

Introduction

Are you measuring your pH properly?

pH is a vital parameter throughout many laboratory processes. Accurate pH analysis requires the right equipment, proper sampling, and effective execution. Time invested in pH analysis without the right equipment results in process wasted.

This eBook focuses on how to implement an effective pH analysis program. It covers the theory of pH, the necessary tools, and how to use these tools to get accurate results.

Hanna Note

- Even though there is a correlation between pH and acidity, they are mutually exclusive.
- Acidity is the concentration of acid present a solution, measured by titration.
- pH is the degree to which something is acidic or basic, measured using a pH meter and electrode.

Why pH Matters

What is pH?

In technical terms, pH, or “potential of hydrogen”, is the hydrogen ion activity in a solution. It’s measured on a logarithmic scale from 0 to 14, with 7 being neutral because the activity of positively charged hydrogen ions (H^+) and negatively charged hydroxide ions (OH^-) is equal. At low pH values (from 1 to 6), the hydrogen ion activity is greater so the solution is acidic. At high pH values (from 8 to 14), the hydroxide ion activity is greater and the solution is basic.

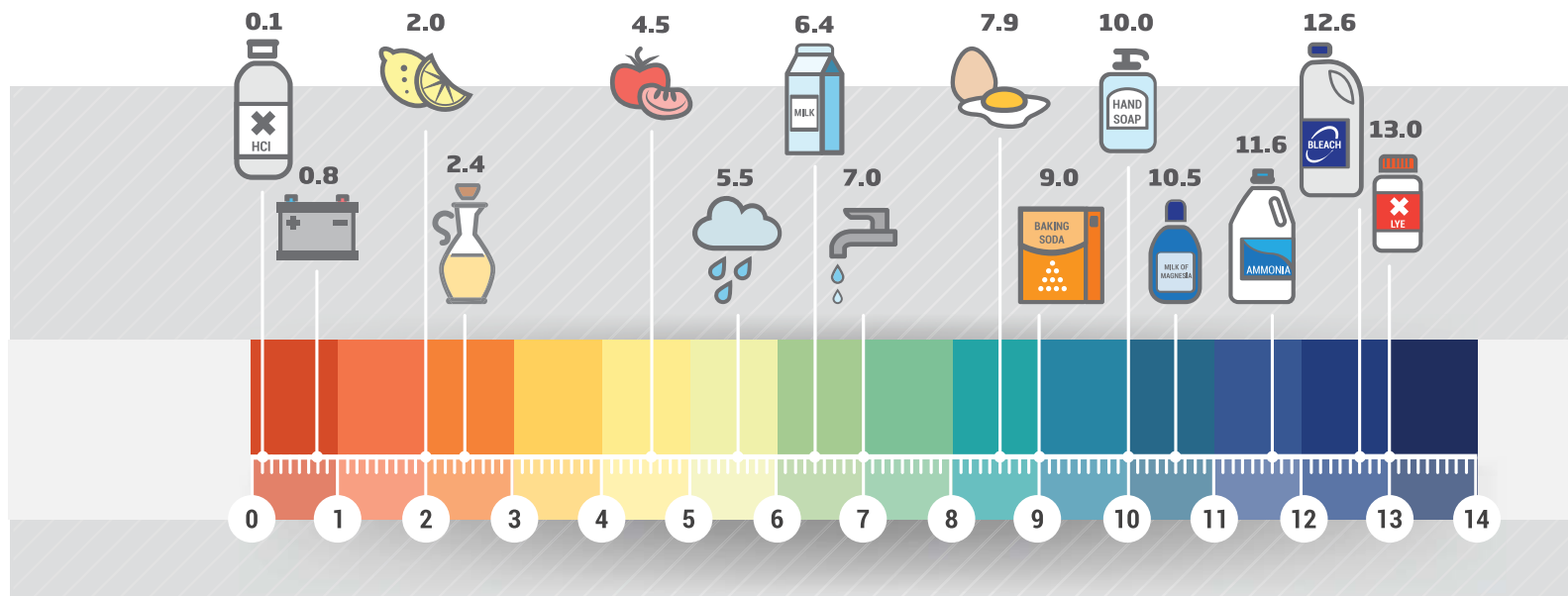

Why pH Matters

Temperature and pH



As a solution increases in temperature, ion mobility also increases.



As a solution decreases in temperature, ion mobility also decreases.

1. The Solution Temperature Effect

When there is an increase or decrease in the temperature of a solution, the actual pH of the solution can change.

2. The Electrode Temperature Effect

Since pH is a measurement of hydrogen ion activity, the temperature-driven change in ion movement translates to a change in electrode response. This also changes the correlation between the electrode potential and pH. Automatic temperature compensation (ATC) accounts for this, providing you with the most accurate measurements.

Hanna Note

- Improper technique of pH testing can result in errors of up to 0.5 pH - enough to result in serious quality issues.

What You Need

Equipment

- 1 pH meter
- 2 Electrode suited to your needs
- 3 Magnetic stir plate and stir bars
- 4 Beakers
- 5 Lab wash bottle

Solutions

- 6 Electrode storage solution
- 7 pH calibration buffers (e.g. pH 4.01, 7.01, 10.01)
- 8 Cleaning solution
- 9 Pure water (e.g. deionized (DI), reverse osmosis (RO), distilled)
- 10 Electrode fill solution specific to electrode*



*Only applies to refillable pH electrodes.

What You Need

Features of an Ideal pH Meter



Flexibility: A hybrid meter gives you the option to use it as a benchtop instrument or carry it to where you are measuring. A built-in battery will give the greatest versatility.

Ease of use: Measurement, configuration, calibration, diagnostics, and logging should be easy with data management features including direct / USB data transfer and the ability to save large data logs.

Simple maintenance: An ideal pH meter has electrode diagnostics to inform you if your calibration buffers are contaminated or if the electrode needs cleaning.

What You Need

Features of an Ideal Electrode

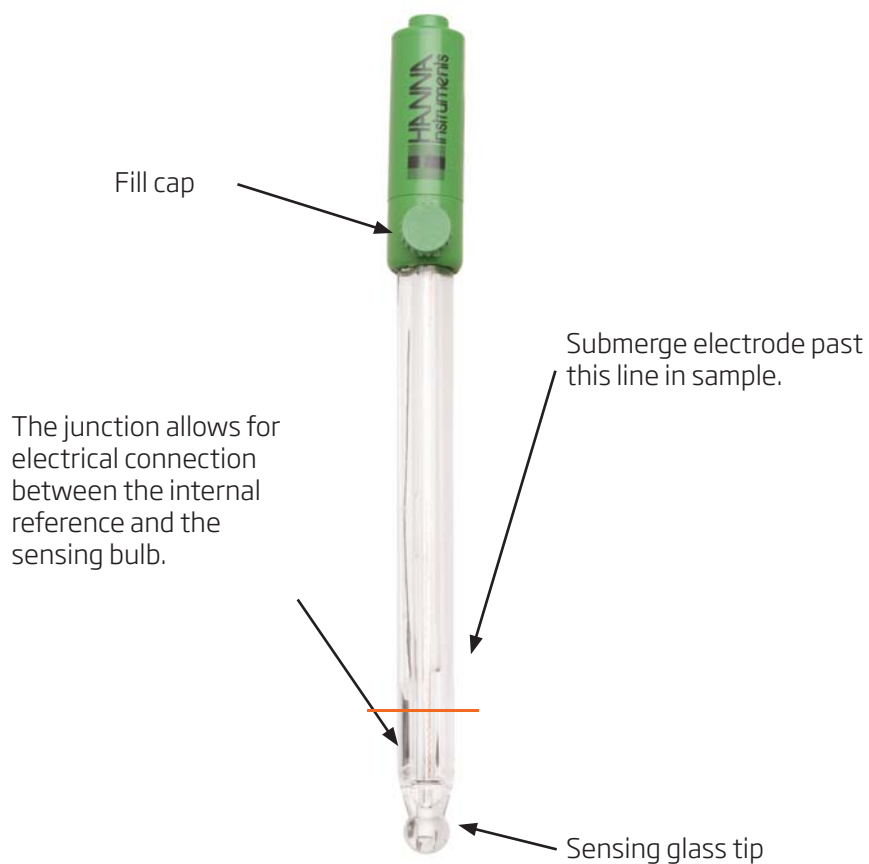

Most meters come with general purpose electrodes. Although these work well for many applications, there are a number of applications that require specialized electrodes such as food, beverage, cosmetics, water treatment, plating and more. **Several factors play into choosing the proper electrode:**

Tip shape: The sensing bulb of a pH electrode is manufactured in different shapes. Each shape serves a unique purpose.

Glass membrane: Choosing the right pH membrane glass type ensures the highest quality measurements with the greatest degree of accuracy.

Junction design: The type of junction used with a pH electrode is one of the most important design considerations when selecting the right electrode.

Electrode body: The body of a pH electrode can be made of various materials.

Hanna Note

- Handling the glass tip of the electrode, wiping it clean, or failing to clean correctly reduces its working life and can impact accuracy.

What You Need

Tip shape

Our sensing membranes are fabricated in four different shapes; each serving a unique purpose to maximize sensor accuracy, response, and longevity.



Spheric profile

Spheric tips are recommended for general use in aqueous solutions. The round bulb geometry is the most common shape for a glass pH membrane and provides a wide surface area for a variety of liquid samples.



Conic profile

Best used in slurries, emulsions, semi-solids, and solid samples; conic designs are ideal for direct penetration into samples due to their pointed profile and geometric strength. These tips are well suited for samples ranging from soils and gels, to sauces, cheeses, and meats.



Flat profile

A flat-tip geometry allows for a direct surface measurement of a sample. These designs are ideal for measuring the pH of flat surfaces, small volume samples, or agar plates. When combined with a concentric PTFE junction, these sensors are excellent for measuring the pH of unknown spills in the field or laboratory.



Dome profile

Similar to a spheric profile, dome profiles are used where a smaller profile would either enhance functionality, such as in electrodes with clog preventing technology, or where space is necessary during electrode construction, such as in protected bulb electrodes.

What You Need

Glass Membrane

The characteristics of the glass membrane are extremely important in determining how the electrode will respond. Characteristics of pH glass include workability (what shapes can be made with a certain glass composition), impedance of the glass (influenced by shape and thickness), pH range, temperature range, and abrasion resistance.

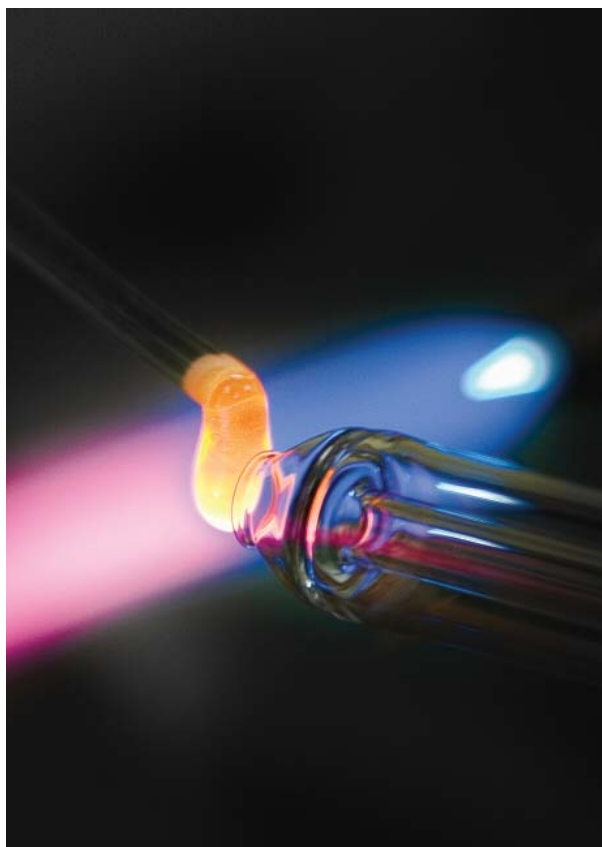

General purpose (GP) glass

Our general purpose hydrogen sensitive glass provides the greatest response over the entire pH range and can be used for a wide variety of applications. This composition of glass is typically used with a spheric bulb geometry.

Low temperature (LT) glass

Low temperature glass membranes have a lower impedance and are suitable for samples at lower temperatures and lower conductivities. They are often offered in flat or conic geometries.

High temperature (HT) glass

Designed for extended use at elevated temperatures where glass impedance is known to decrease, high-temperature glass offers a higher resistance making it possible to obtain accurate results with excellent response times. This composition of glass is typically used with a spheric bulb geometry.

What You Need

Junction design

The type of junction used in a pH electrode is one of the most important design considerations when selecting the right sensor for your application. The junction is the electrical pathway between the sample and the internal reference half-cell. This reference chamber contains an electrolyte solution, which diffuses through the junction into the sample. Any clogging of this junction may result in erratic and unstable readings.



Porous ceramic

A porous ceramic frit is one of the most common junctions available for standard laboratory applications. The ceramic material is easily fused with the electrode glass and has a similar coefficient of expansion. A single electrode may contain a single, double, or triple ceramic frit allowing for enhanced electrolyte flow.



PTFE sleeve

A PTFE sleeve surrounding an open junction is an excellent choice for applications in samples with high amounts of solids such as slurries, sauces, or wine must. The sleeve design allows for high electrolyte flow and prevents clogging that could otherwise inhibit accurate results.



Open design

Open style junctions are filled with a special gel electrolyte that directly contacts the sample. An advantage of an open junction is low contact resistance and low clogging potential. They are ideal for solid and semi-solid samples, and emulsions.

What You Need

Electrode body

The body of a pH electrode can be constructed from a variety of materials that may help to make pH measurements easier. The right body material will vary depending on the testing environment, the sample type, and the frequency of use.



Glass body

Glass bodies are a staple of pH electrode design. Glass is resistant to a variety of chemicals, is easy to clean, and transfers heat readily for fast thermal equilibrium between the sample and the sensor. Glass body electrodes are ideal for any type of laboratory application.



PEI body

Polyetherimide is a high-performance, durable plastic that offers excellent resistance against aggressive chemicals. Rugged and resilient, PEI electrodes are ideal for environmental or industrial applications in the field or on the factory floor.



PVDF body

Polyvinylidene fluoride is food grade plastic that stands up to a variety of cleaning chemicals and solvents. It is durable and has a high resistance to abrasion, mechanical strength, and resistance to fungal growth.

What You Need

Solutions

Calibration solutions: pH electrode calibration is an important step because of how the electrode changes over time.

Electrode cleaning solutions: Our general purpose and application specific pH cleaning solutions eliminate residues without damaging the electrode.

Electrode storage solution: A storage solution is designed to keep the electrode bulb hydrated and ensure optimum performance. Properly stored electrodes exhibit higher accuracy and have a longer lifespan.

Electrode fill solution: The electrode fill solution, or electrolyte, electrically connects the pH meter and electrode with the sample being tested. Levels of electrolyte should regularly be maintained.



Hanna Note

- Use fresh buffers for calibration and replace buffers which have been opened for more than 1-2 months.
- Always keep the electrode fill solution topped off.
- Bracketing is the process of calibrating a pH meter to points above and below the expected pH range of the samples being tested.

How to Measure

1. Setup (Before You Measure)

a. Electrode Preparation

- Remove protective cap from the electrode.
- Inspect the electrode for any scratches or cracks. If visible, replace the electrode.
- Shake the electrode down to remove any air bubbles inside the glass bulb.
- Ensure that the electrode was cleaned and stored properly (See Section 3: Maintenance).
- Remove the fill cap (if applicable).
- Rinse electrode with pure water to remove any salt deposits.

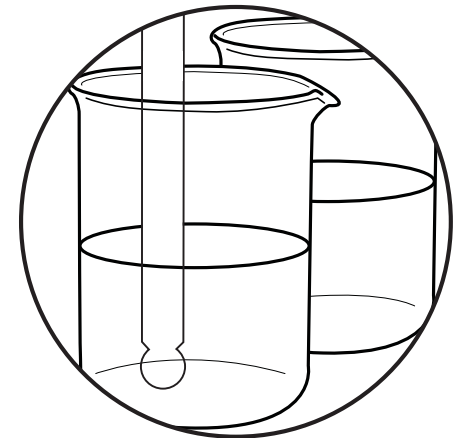
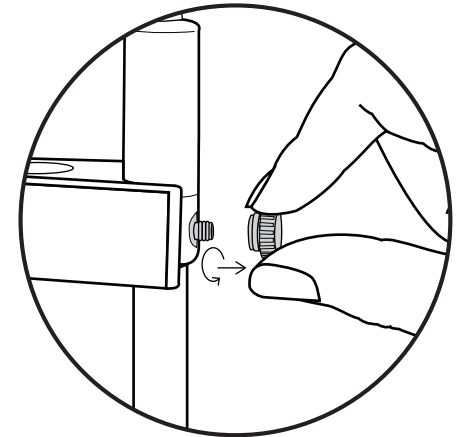

How to Measure

b. Calibration

- Fill a beaker with enough pH calibration buffer to cover the electrode junction (about 75 mL in a 100 mL beaker).
- Place the electrode in the beaker containing pH calibration buffer and gently stir.
- Confirm the calibration point when the reading is stable.
- Repeat for additional calibration points. Be sure to rinse with pure water between calibration points. At least two calibration points are recommended.

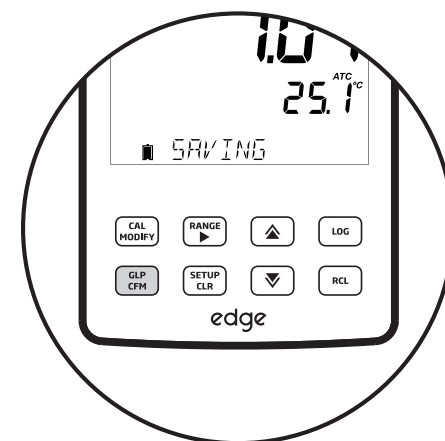

Hanna Note

- In general, pH 4 and 7 buffers can last 4-8 weeks after opening, and an alkaline pH buffer (i.e. pH 10) will last 1-2 weeks after opening.
- Calibrate the electrode after extended storage, cleaning, and before use.
- If readings are slow to stabilize the electrode may need to be cleaned or the electrolyte may need to be changed.

How to Measure

2. Measurement

a. Liquid Samples

- Rinse the electrode with pure water.
- Immerse the tip in the sample and stir gently, or use a magnetic stirrer.
- Wait until the reading is stable.
- Rinse the electrode with pure water until all residue is removed.
- Repeat this procedure for additional samples.

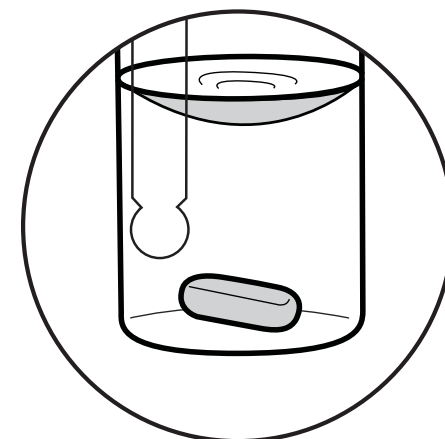

b. Solid Samples

- Rinse the electrode with pure water.
- Use a knife or auger to make a hole for the pH electrode. Some pH electrodes have an integrated blade. In these cases, simply insert the probe into the sample.
- Insert the tip of the probe into the hole. Ensure electrode junction coverage by placing the electrode at least 2 cm (0.75") into the sample.

Hanna Note

For solid or semi-solid samples, it is possible to create a slurry of deionized water and solid sample and perform measurements as a liquid sample. Follow approved methods.

How to Measure

3. Maintenance (After You Measure)

a. Electrode Cleaning

- Fill a 100 mL beaker with approximately 75 mL cleaning solution.
- Place the pH electrode into the cleaning solution for at least 10-20 minutes, making sure the junction is covered.
- If a refillable electrode is visibly contaminated, drain the reference electrolyte chamber with a syringe or capillary pipette and refill with fresh electrolyte.

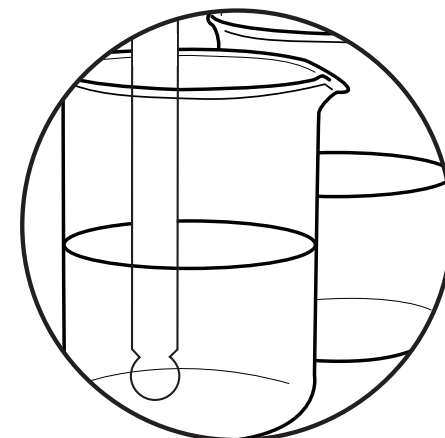

b. Electrode Storage

- Replace the storage solution in the protective cap or beaker.
- Submerge the glass bulb and junction in protective cap or beaker with solution.
- A dry electrode should soak in storage solution for at least 1-2 hours prior to use and should be re-calibrated. However, overnight is optimal.

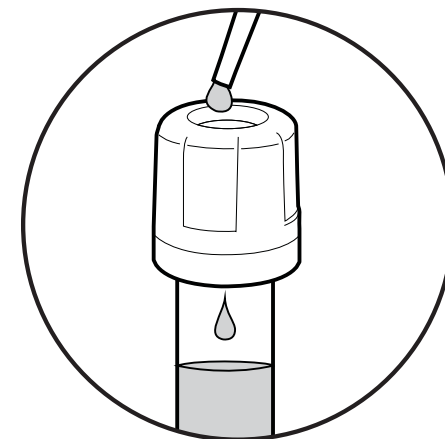

How to calculate the slope and offset of a pH electrode

Check

Some meters are able to display the probe condition automatically after a calibration, but for those without automatic diagnostics, you can manually check the slope and offset beforehand if your meter has mV mode. An offset between ± 30 mV and a slope percentage between 85% and 105% is a sign the electrode is working properly.

If you find your electrode is outside of these values, give us a call. You may need to replace your electrode.

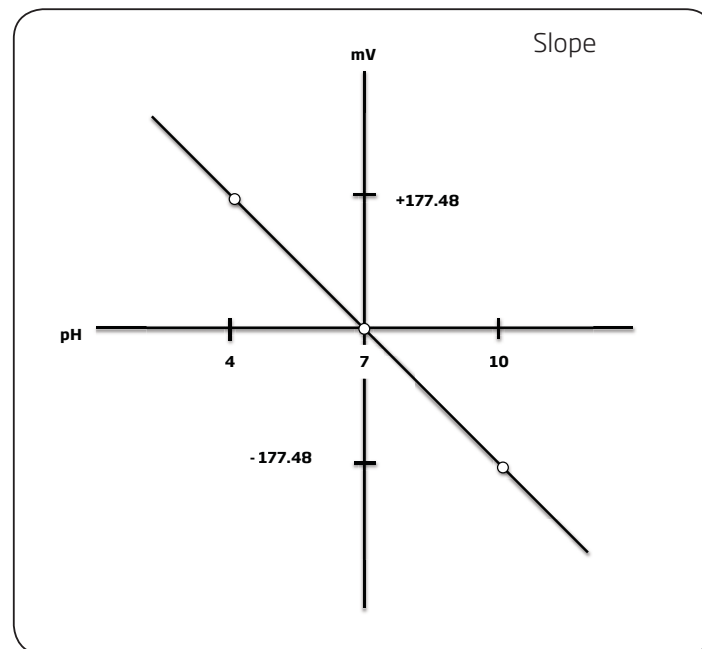

How to calculate the slope and offset of a pH electrode

1. Put meter in mV mode.
2. Measure and record the mV value in pH 7.01 buffer; this is the electrode offset.
3. Measure the mV value in a second buffer, such as pH 4.01.
4. To determine the electrode slope, calculate the absolute mV difference in between the two buffers.
5. Divide this by the difference of pH units between buffers. (Example: the difference in pH units between 7.01 buffer and 4.01 buffer is $7.01 - 4.01 = 3$).
6. To convert this result to electrode slope percentage, divide the electrode slope by the theoretical maximum slope (59.16 mV/pH unit @ 25°C), and multiply by 100.

$$\% \text{ slope} = \frac{(\Delta \text{mV} / \Delta \text{pH units})}{(59.16 \text{ mV} / \text{pH units})} * 100$$

Sample Calculation

Electrode 1 generates -15 mV in pH 7.01 and +160 mV in pH 4.01. Absolute mV difference: $+160 \text{ mV} - (-15 \text{ mV}) = +175 \text{ mV}$

$$\% \text{ slope} = \frac{(175 \text{ mV} / 3 \text{ pH units})}{(59.16 \text{ mV} / \text{pH units})} * 100 = \left(\frac{58.33}{59.16} \right) * 100 = 98.6\%$$

Electrode 2 generates +15 mV in pH 7.01 and +160 mV in pH 4.01. Absolute mV difference: $+160 \text{ mV} - (+15 \text{ mV}) = +145 \text{ mV}$

$$\% \text{ slope} = \frac{(145 \text{ mV} / 3 \text{ pH units})}{(59.16 \text{ mV} / \text{pH units})} * 100 = \left(\frac{48.33}{59.16} \right) * 100 = 81.7\%$$

Conclusion: Both have acceptable offsets. Electrode 1 has an offset of -15 mV and a slope of 98.6% while electrode 2 has an offset of +15 mV and a slope of 81.7%. Electrode 1 is working properly while electrode 2 has an unacceptable slope. If changing the fill solution, cleaning the electrode, and calibrating does not correct these values, replace the electrode.

pH Measurement Checklist

Setup (Before You Measure)

Electrode Prep

- Remove protective cap from the electrode.
- Inspect the electrode for any scratches or cracks. If present, replace the electrode.
- Shake the electrode down to remove any air bubbles inside the glass bulb.
- Ensure that the electrode was cleaned and stored properly.
- Rinse electrode with pure water to remove any salt deposits.

Calibration

- Fill a beaker with enough [pH calibration buffer](#) to cover the electrode junction (about 75 mL in a 100 mL beaker).
- Place the electrode in the beaker containing pH calibration buffer and gently stir.
- Confirm the calibration point when the reading is stable.
- Repeat for additional calibration points. Be sure to rinse with pure water between calibration points. At least two calibration points are recommended.

NOTE: In general, pH 4 and 7 buffers can last 4-8 weeks after opening, and an alkaline pH buffer (i.e. pH 10) will last 1-2 weeks after opening.

Measurement

Liquid Samples

- Rinse the electrode with pure water.
- Immerse the tip in the sample and stir gently, or use a magnetic stirrer.
- Wait until the reading is stable, before recording the measurement.
- Rinse the electrode with pure water until all residues are removed.
- Repeat this procedure for additional samples.

NOTE: For solid or semi-solid samples, it is possible to create a slurry of deionized water and solid sample and perform measurements as above. Follow approved methods.

Solid Samples

- Rinse the electrode with pure water.
- Use a knife or auger to make a hole for the pH electrode. Some pH electrodes have an integrated blade. In these cases, simply insert the probe into the sample.
- Insert the tip of the probe into the hole. Ensure electrode junction coverage by placing the electrode at least 2 cm (0.75") into the sample.

Maintenance (After You Measure)

Electrode Cleaning

- Fill a 100 mL beaker with approximately 75 mL [cleaning solution](#).
- Place the pH electrode into the cleaning solution for at least 15 minutes, making sure the junction is covered.
- If a refillable electrode is visibly contaminated, drain the reference electrolyte chamber with a syringe or capillary pipette and refill with fresh electrolyte.
- Place in storage solution.
- Rehydrate for 1-2 hours before calibration and measurement.

Electrode Storage

- Replace the [storage solution](#) in the protective cap or beaker.
- Submerge the glass bulb and junction in protective cap or beaker with solution.
- A dry electrode should soak in storage solution for at least 1-2 hours prior to use and should be re-calibrated. However, overnight is optimal.

Best Practices



Keep the electrode hydrated

Why: Drying out the electrode leads to drifting pH values, slow response times, and incorrect measurements.

Fix: "Revive" a dry electrode by submerging the bulb and junction in pH storage solution for at least 1-2 hours, overnight is recommended.

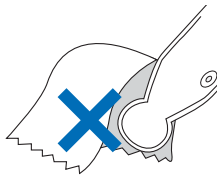

Rinse, do not wipe your electrode

Why: Wiping the pH glass can produce a static charge which interferes with the pH reading of the electrode.

Fix: Simply rinse the electrode with pure water.

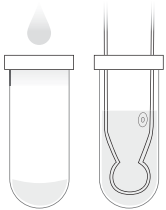

Properly store your electrode

Why: To minimize junction clogging and to ensure fast response time, it is important to keep your glass bulb and pH junction hydrated.

Fix: Store your electrode in storage solution. Deionized (DI) water is too dilute and pH buffer is too salty for storage purposes.

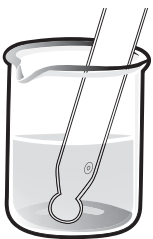

Clean your electrode regularly

Why: Deposits can form on the electrode during use, coating the sensing glass. This can lead to erroneous calibrations and readings.

Fix: Clean the electrode using a specially formulated cleaning solution for pH electrodes—ideally one that's developed for your application.

Best Practices

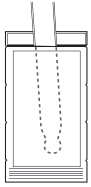

Calibrate often

Why: All pH electrodes need to be calibrated often for best accuracy.

Fix: The frequency of calibration depends on how accurate you want to be - daily calibration is ideal. If the pH electrode is used daily and/or in aggressive conditions.



Pick the right electrode for your sample

Why: General purpose electrodes are functional for a wide variety of applications but not ideal for all samples.

Fix: Based on your sample you may require an electrode designed for food, high/low temperature, non-aqueous, or other types of samples.

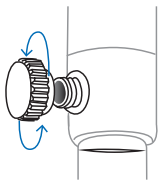

Open or loosen the fill hole cap

Why: A closed electrode fill hole may lead to slower stabilization times.

Fix: Loosen or remove the fill hole cap. Remember to put it back when storing the electrode (not applicable for non-refillable electrodes).

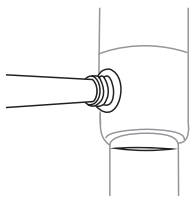

Inspect your electrode

Why: Over time, the sensing portion of the glass becomes less responsive and will eventually fail. Damage from use is also possible. This will cause erroneous readings.

Fix: Check your electrode for damage and perform a slope and offset calculation.

Best Practices

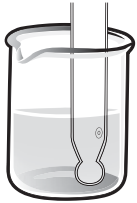

Keep the electrolyte level full

Why: Electrolyte flows out from the reference junction over time. Low electrolyte levels may cause erratic readings (not applicable for non-refillable electrodes).

Fix: Ensure that your electrode fill solution level is no less than one-half inch from the fill hole cap.



Properly submerge your electrode

Why: Both the pH sensing glass and reference junction need to be completely immersed in order to function properly.

Fix: Add enough sample to submerge both the junction and sensing glass.

THANKS FOR READING!

LEARN MORE

Our experts are here to help you.

Visit us at
hannainst.com

Email us at
info@hannainst.com

Call us at
1 (877) MY-HANNA